



MAHA BODHI SCHOOL  
2025 SCIENCE REVIEW 1  
PRIMARY FOUR

Name : \_\_\_\_\_ ( )

Date : 9 May 2025

Class : Primary 4 \_\_\_\_\_

Duration : 40 min

Marks: 

/ 30
------

Parent's signature : \_\_\_\_\_

**Section A : [8 x 2 marks = 16 marks]**

For each question from 1 to 8, four options are given. One of them is the correct answer. Make your choice (1, 2, 3 or 4). Write your answer in the bracket.

1. The diagram shows a plant.

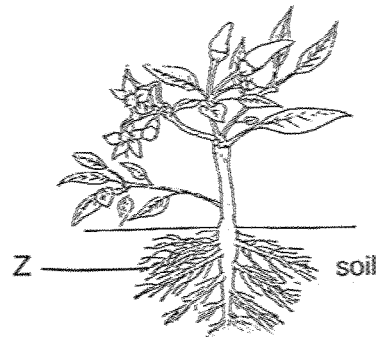

What is part Z?

- (1) leaf
- (2) root
- (3) stem
- (4) flower

( )

2. Which of the following below is not part of the respiratory system?

- (1) nose
- (2) heart
- (3) lungs
- (4) windpipe

( )

Marks : 

/ 4
-----

3. The diagram below shows the human digestive system.

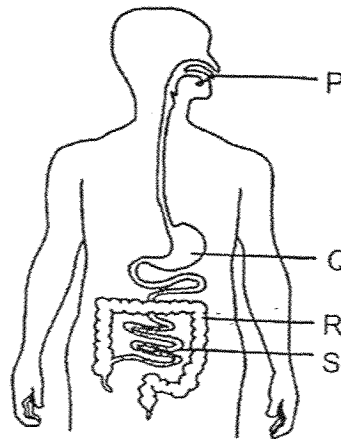

Which statement is wrongly matched to the part?

	Part	Statement
(1)	P	Digestion starts here.
(2)	Q	Digested food is absorbed here.
(3)	R	Water is absorbed here.
(4)	S	Digestion ends here.

( )

4. A magnet brought near an aluminium rod as shown below.



What will happen to the aluminium rod?

- (1) It will not move.
- (2) It will spin continuously.
- (3) It will move to the magnet.
- (4) It will move away from the magnet.

( )

Marks :  / 4

5. In which of the following arrangements will the two magnets attract each other?

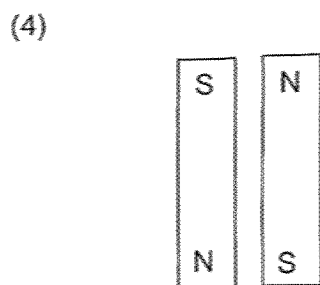
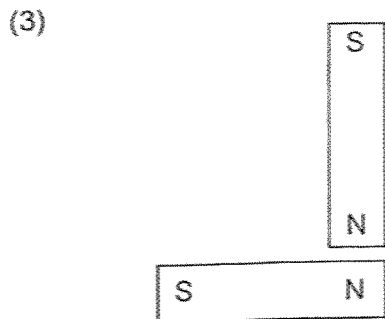
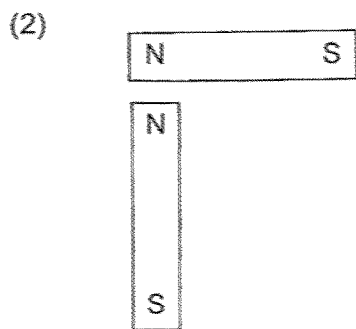
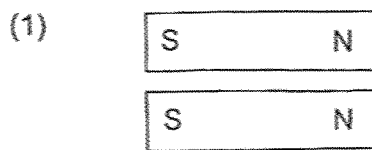

( )

Marks :

6. Ali grew some plants on his farm as shown below.

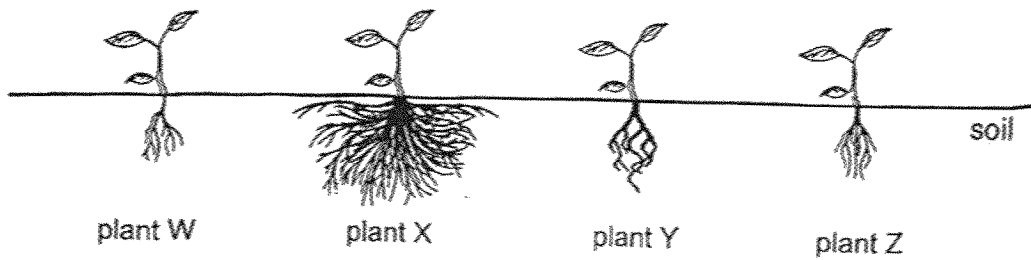

Which of the plants above is least likely to be pulled out of the soil by strong winds when a storm hits the farm?

- (1) Plant W
- (2) Plant X
- (3) Plant Y
- (4) Plant Z

( )

7. The flow chart below shows part of the human digestive system.

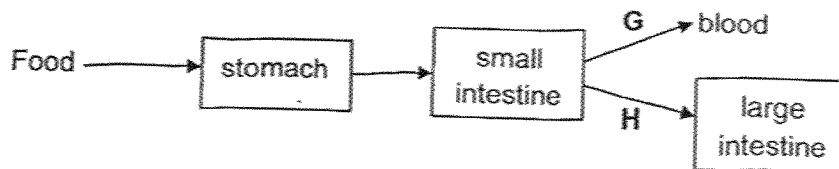

Which of the following correctly identifies the type of food at G and H?

	G	H
(1)	digested food	digested food
(2)	digested food	undigested food
(3)	undigested food	digested food
(4)	undigested food	undigested food

( )

Marks :  / 4

8. Electromagnets X, Y and Z have similar batteries and iron nails as shown in the diagrams below.

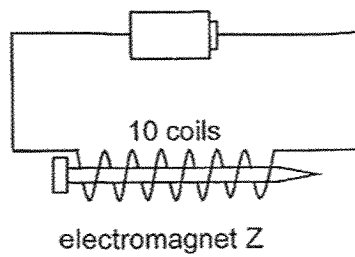
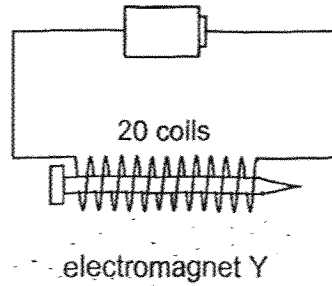
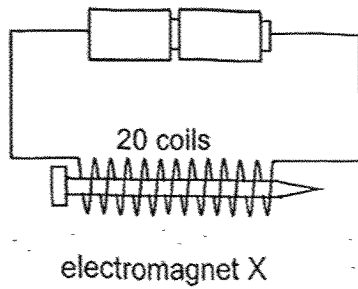

Which of the following shows the correct arrangement of the strongest electromagnet to the weakest electromagnet?

	Strongest	→	Weakest
(1)	X		Y
(2)	X		Z
(3)	Y		Z
(4)	Y		X

( )

Marks :  / 4

**SECTION B : [14 marks]**

For questions 9 to 12, write your answers in this booklet.

The number of marks available is shown in the brackets [ ] at the end of each question or part-question.

9. The diagram below shows two plants A and B.

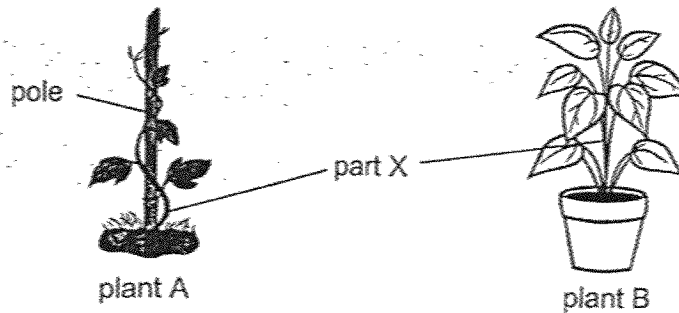

(a) Based on the diagrams, how are part X of plant A and plant B different? [1]

---

---

(b) State the function of the stem of a plant. [1]

---

(c) Jane carried out an experiment on 2 potted plants, C and D. For each plant, she removed a different plant part as shown below.

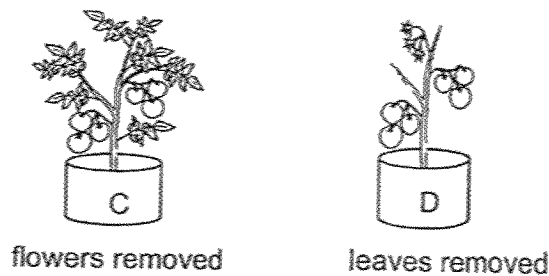

She placed both potted plants under the sun and gave them same amount of water every day.

Which plant, C or D, would most likely die first? Explain your answer. [2]

---

---

---

Marks: 

/ 4
-----

10. Mrs Lee carried out an experiment to find out how the surface area of food affects the speed of digestion. She placed potato slices in three beakers with digestive juice as shown below.

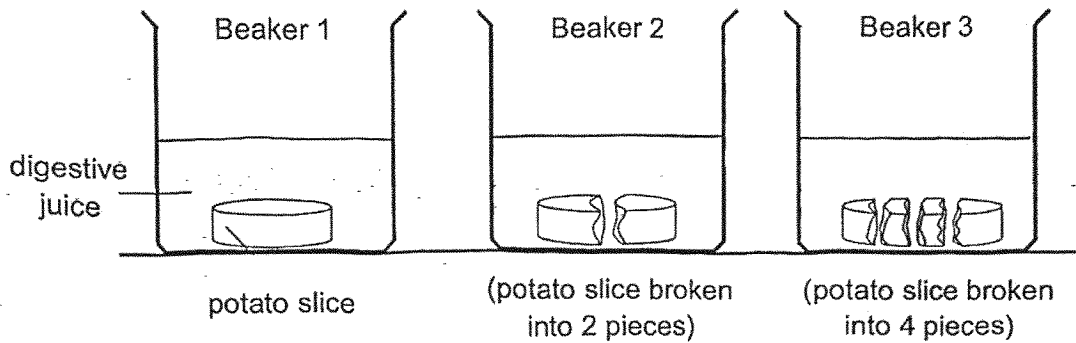

The time taken for the potato slices to be digested completely was recorded in the table below.

Potato slice in	Time taken (mins)
Beaker 1	11
Beaker 2	6
Beaker 3	3

- (a) Name one part of the digestive system that produces digestive juices. [1]

---

- (b) State the variable that was measured in this experiment. [1]

---

- (c) Based on the results above, explain how chewing food into smaller pieces helps digestion. [2]

---



---



---



---

Marks:  / 4

11. Three ring magnets, E, F and G are arranged as shown below.

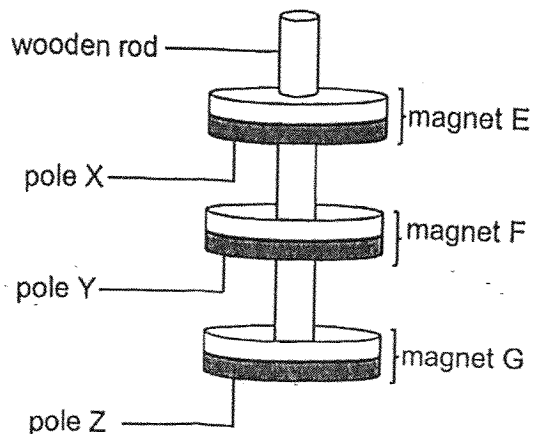

(a) If pole Y is South pole, identify the poles X and Z. [1]

X : \_\_\_\_\_ pole

Z : \_\_\_\_\_ pole

(b) What will happen when magnet E is flipped so that pole X is facing upwards? [1]

---

---

Marks: 

/ 2
-----

12. A magnet placed on a float was allowed to move freely on a basin of water as shown below.

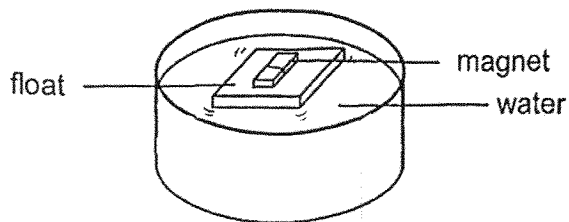

- (a) In which direction would the magnet come to rest after a while? [1]

---

- (b) The magnet was removed and placed into a box of pins. The pins were attracted to the magnet as shown below.

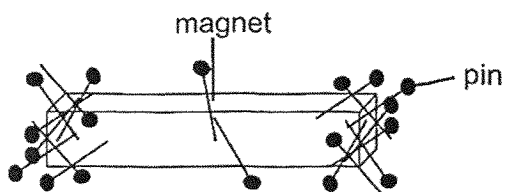

- (i) Based on the above observation, what can be concluded about the magnetic strength of the magnet. [1]

---

---

- (ii) The magnet was then removed and placed into a box of plastic clips. What would you observe about the plastic clips? Explain why. [2]

---

---

---

Marks:

/ 4

~ END OF PAPER ~



**SCHOOL : MAHA BODI SCHOOL**  
**LEVEL : PRIMARY 4**  
**SUBJECT : SCIENCE**  
**TERM : 2025 WEIGHTED ASSESSMENT 1**

Q1	2
Q2	2
Q3	2
Q4	1
Q5	4
Q6	2
Q7	2
Q8	1
Q9	a) Plant A has weak stem but Plant B has a strong stem. b) To keep the plant upright. c) Plant D. Plant D has no leaves so it cannot make food for the plant.
Q10	a) Stomach b) The time taken for the potato slice to be digested completely. c) The food has a greater surface area and so the food gets digested faster.
Q11	a) X: North pole Z: North pole b) Both E and F are attracted to each other.
Q12	a) North – south direction b) i) The magnetic strength is strongest at its poles. ii) The magnet did not attract the plastic clips. Plastic is a non-magnetic material.

